



**HIGH PERFORMANCE**

**HF RECEIVING SYSTEMS & COMPONENTS**

**Hi-Z Antennas™ 8 Element Narrow Systems \*\***



**Hi-Z 8A-160 (160 meters) 200 Foot Diameter Circle  
Hi-Z 8A-80 (80 meters) 100 Foot Diameter Circle  
(A models have the Pre-amp external)  
*Level2 with PLUS6 Amps***

**Hi-Z Amp PLUS6 Information located at the end of this manual**

## **Constructing a LOW-Band (160, 80 meter) Receiving Narrow 8 Element Circular Antenna System**

**Please read the entire manual before proceeding with your install.**

### **Specifications Hi-Z 8A – 160 & Hi-Z 8A – 80**

- 13.5db RDF, Super Directive Array
- 8 crisp directions every 45 degrees, with 52 degree view per direction for total direction control
- Power is 13.8VDC at 420ma
- Upgradeable – future Hi-Z optional modules expanding capabilities

Check to see that all parts were received.

- 8125 Hi-Z 8A Phase Controller
- 1 – Hi-Z 8 direction Shack Switch
- 8 – Hi-Z Amp PLUS6
- 1 – Hi-Z 75Ω In-line Pre-amp PLUS
- 1 – Hi-Z 75Ω to 50Ω Transformer
- 1 – 2 foot long RG6 cables (to inserted the Pre-amp)
- 1 – 2 foot long wire with terminals (power to Inline pre-amp)

### Options

- BCB Filter
- HPF

**At the end of this manual there is a chart of measurements to layout your array.**

### ***Material That the Customer Supplies –***

1. Control cable (7 conductor –5 wires for control and 2 for power)
2. Short two conductor cable for DC power. Hi-Z supplies the connector for the shack switch.
3. 8 verticals See: [http://www.hizantennas.com/hiz\\_verticals.htm](http://www.hizantennas.com/hiz_verticals.htm)
4. 8 short ground rods. Depending on soil type, in the range of 2 –3 feet long.
5. RG6 coax and connectors (connecting the verticals to the phase controller and from phase controller / in-line pre-amp to shack receiver location). RG6 coax is more than adequate to lengths out to 1000 feet long.
6. Make 16 9-10" long wires. Wire size can be made from 18 – 20 gauge wire. Terminate each end with #6 ring terminals. Recommend that after the terminals are crimped, that these terminals are soldered for reliability. For Hi-Z PLUS6 Amp terminations.
7. **Weatherproofing the electronics.** You will need an adequate cover or enclosure that will keep rain and snow off the phase controller, in-line pre-amp and filters if installed, and the Hi-Z PLUS6 Amps at the base of each vertical. Water getting inside of these enclosures WILL cause DAMAGE.

The Hi-Z Antennas 8 elements receiving system utilizing shortened vertical elements has been designed to provide a high-performance receiving antenna for the Amateur low bands covering 160 or 80 meters. The unique advantage of the 8-element system is that it can be switched electrically to provide receiving capability in eight different directions. This system is also somewhat unique in that it uses high-impedance amplifiers at each antenna to extract the signals. Using these amplifiers negates the need for an extensive ground radial system around each antenna element in most areas with decent (1-2 foot deep dirt, not rock) ground conditions. This system can be used in place of the well-known Beverage receiving antennas that use very long wire elements and only provide one or two receiving directions per wire. This system can also be used in place of various types of receiving loops and arrays of multiple loops. This system when well built will outperform most all other low-band receiving antenna types.

See the antenna comparison chart here: <http://www.hizantennas.com/comparison.pdf>

## **What Can be Achieved With the Narrow 8 Circle Array**

Most receiving systems being compared against another are most often compared for their front to back response ratio and their directivity. Front to back ratio is generally expressed in dB and then directivity, Relative Directivity Factor (RDF) in dB as well. There have been many spacing layout dimensions evaluated in order to get maximum performance from these arrays. The results of this evaluation has shown that for an emphasis on 160 meter band operation the circle dimension 200 feet diameter will give great performance on 160 meters. The same performance on 80 meters requires only a 100-foot diameter. The following plots are based on a 160 meter band diameter of 200 feet and they show the resulting performance characteristics. The phasing delay cable values required in the 8 circle controller has been chosen for optimum performance. .

### **Basic Narrow 8 Circle Element Physical Layout**

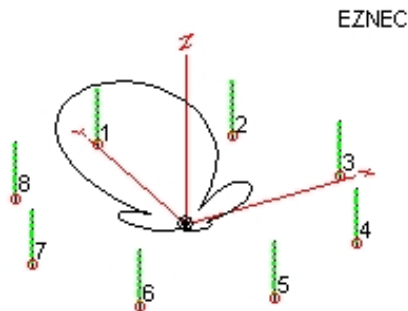

The Narrow 8-Circle physical layout with direction Switchable pattern overlay as seen in the above layout the main lobe of the response is pointing directly at element 1. Electrically this pattern can be switched to point at any of the elements, 1 through 8. .

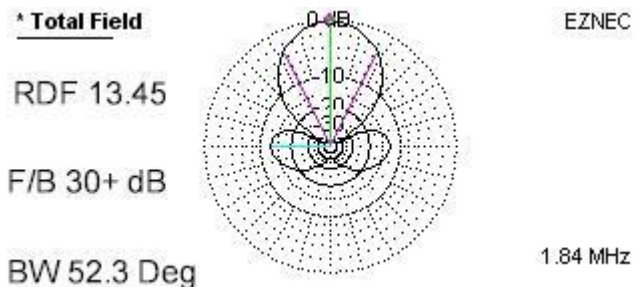

**Narrow 8 – 200 Foot (160 meters), 8- 100 Foot (80 meters) Diameter Azimuth Plot**

The long and short phasing cables are supplied and tested to provide best overall system performance.

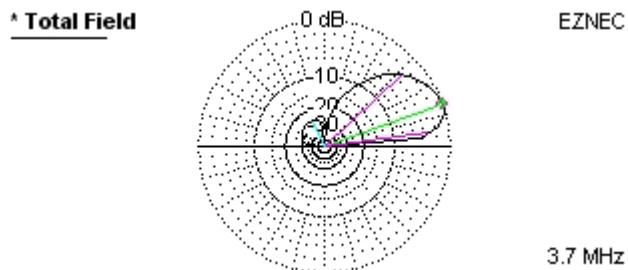

**Narrow 8 Elevation Plot**

Remote Location –  
Hi-Z Components  
Must be in WX Proof  
Enclosure

## Hi-Z 8A Interconnect Diagram

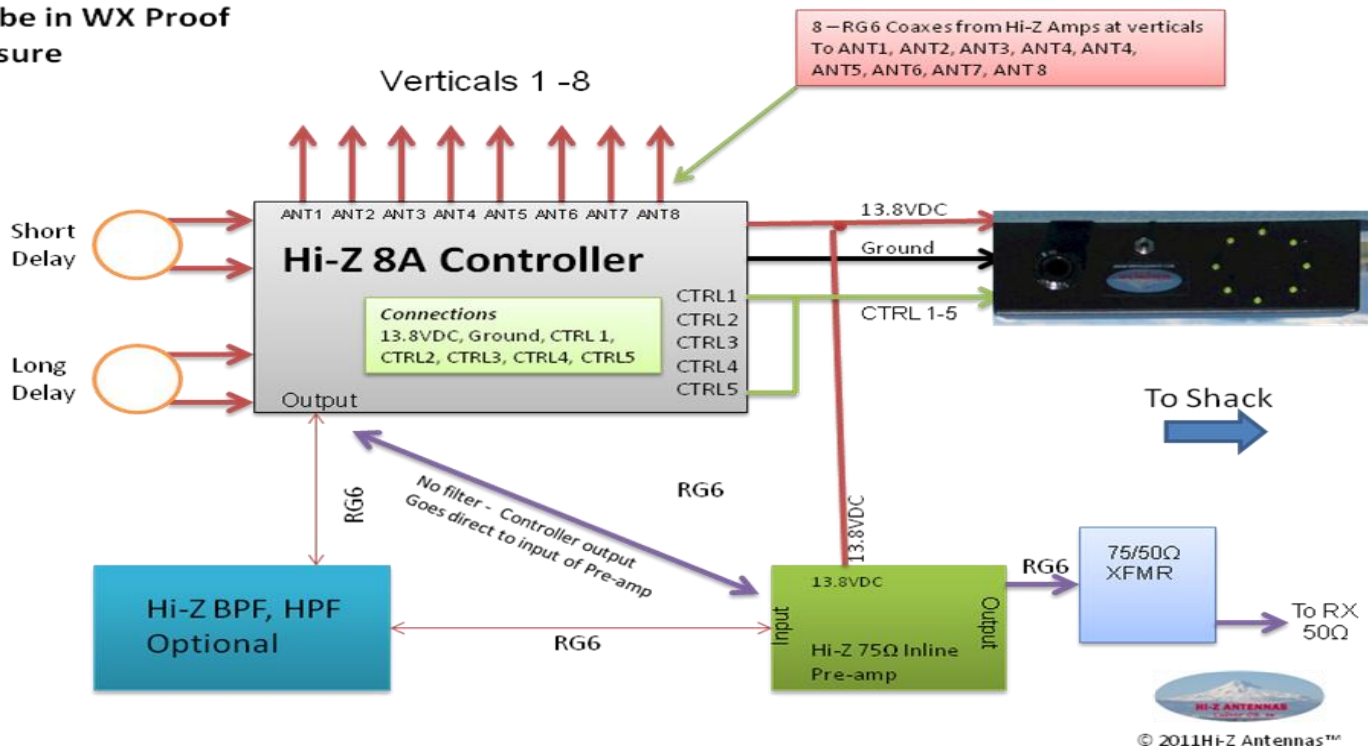

### Constructing Elements for The Array

There are likely as many ways to construct elements for an 8-Circle array, as there are people in the world. What the array needs is 8 insulated vertical elements that are as near identical as possible. Each vertical needs a companion ground rod. For array operation at 160 meters and below the elements should be 15 to 20 feet in length. The 20-foot length has been established to be optimum for best signal output level combined with voltage and phasing accuracy. The penalty in performance when dropping to 15-foot length is indeed real but difficult to measure and there are successful systems using this length. If one were not concerned with 160-meters but only higher bands such as twice the frequency at 80 meters and 100 foot diameter, then a 10-foot element would be fine. There is one 160-meter system presently operating with just 6-foot elements and lowest band performance is marginal at best. It also required measuring and adjusting element voltages and phases very accurately. If you want the best performance, stick with 15 to 24 foot length elements with 20-24foot length being the best.

The diameter of the element has very little effect on the array. Some have used metal tubing while others have used fiberglass fishing rods with small wire strung through the hollow center. A mounting arrangement that utilizes large conducting surfaces close to the element will decrease the signal output of the element. Even wet wood posts should be kept a minimum of 4 inches away from the elements. Plastic or ceramic insulators are the best choice. PVC pipe works well. Each element will require a ground rod driven into at

least 1 to 2 feet of soil. For areas of really bad and dry soil it is recommended to use two or even 3 short ground rods. Two feet length is fine. Pre-made Elements are available at.

[http://www.hizantennas.com/hiz\\_verticals.htm](http://www.hizantennas.com/hiz_verticals.htm)

Over rocky, low conductivity areas it is unclear how well the system will work due to some phase and amplitude shifts in received signal. In the worst of cases it may be necessary to install 6 or so short radials of 6 foot in length. Identical radial layout has been measured to be a necessity with these arrays! There are real and measurable inaccuracies when using radials below these Hi-Z elements. The best recommendation when radials are needed would be stringent accuracy in layout of 6 to 8 each 6-foot long radials below each element. Wire as small as 18 Ga. Would be fine. Do not use radials unless absolutely necessary.

## **Connecting Cables**

The antennas are arranged in a circle configuration with a diameter of 200 feet (160 meters) and 100 feet (80 meters).

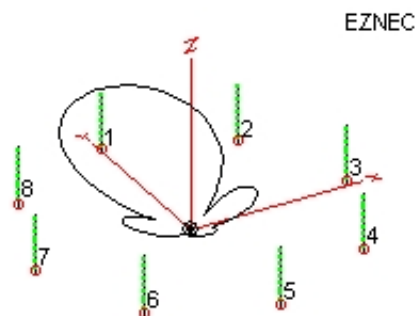

To calculate the needed connecting cables required for sending the signals from each antenna to the center controller one can use the following formula.

Formula: Circle RADIUS plus 4 feet extra cable giving 100 feet plus 4 feet or 104 feet for 160 meters or 54 feet for 80 meters.

The length of these cables is not critical except that they all be the same length and from the same spool of cable. This ensures the phase delay for each cable will be equal and therefore not require any length compensations. Actual length is unimportant due to the impedance matching used in the system.

The way to get identical cables it to utilize one 1000-foot spool of RG-6. Cut 8 each 102-foot lines from the spool for 160 meters or 8 each at 52 feet long for 80 meters. Use quality RG-6 connectors.

The following plot shows the overlap between two selected directions in the Narrow 8 array on 160 meters.

## **Hi-Z Amp PLUS6**

The Hi-Z PLUS6 Amp requires weatherproofing, see our website for suggestion to wx-proof these amps. The PLUS6 amps do not require wx-proofing, BUT the RG6 connection must be correct so as not to leak WATER INTO THE COAX CONNECTION AND ULTIMATELY MIGRATE THE WATER INTO THE INSIDE OF THE ENCLOSURE. Connect 8-10 inch wires to the input terminals of either amp. The Antenna terminal connects to the base of each vertical element and the GND connects to the ground rod at the base of each vertical.



## Level 2 Hi-Z Amp PLUS6

. PLUS6 is a higher gain amplifier.

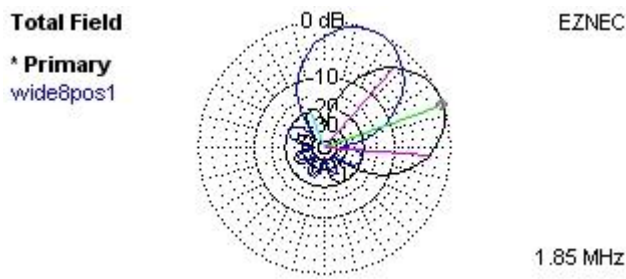

## Connecting The Elements

It is very important to connect the elements to the center controller in numerical and shack switch matching order as shown in the antenna view. One can certainly physically put your antenna 1 in any direction of the compass. Direction 1 is typically North. That way when the Hi-Z antennas shack switch is used the LED indicators will indicate direction just like looking at a North Up map.

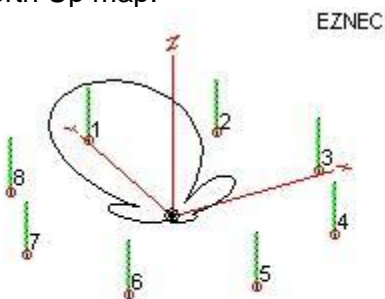



**Shack Switch**

The controller has 5 directional control connections plus a ground and +13.8V supply terminal. It is highly recommended that you use a good copper round wire in addition to the coax shield to reduce DC voltage drop to the controller. For runs up to 500 feet a control cable of #16 or #17 wire are adequate. Actually the control lines can be smaller gauge, but the DC wires must be larger. Number 18 gauge or similar would be adequate for the direction control lines.

CONNECTIONS Between	13.8VDC	GNND	CTRL1	CTRL2	CTRL3	CTRL4	CTRL5
Shack Switch	X	X	X	X	X	X	X
Phase Controller	X	X	X	X	X	X	X



**Rear View – Shack Switch**

The control cable should be connected between the shack switch and the controller connections as seen below. The supplied delay cables (SHORT, LONG) should be connected to “Short Delay” connectors and the “Long Delay” connectors on the phase controller.

Array power is supplied through the array power connector. This allows the front panel toggle switch on the front panel of the shack switch to switch the entire array on and off. The +13.8 terminal is used for sending power out the control cable to the controller in the center of the array.

There is a 2 foot RG6 cable and 2 foot wire with fork lugs supplied with system. The 2 foot RG6 cable connects from the Phase Controller Output to the Input of the 75Ω Pre-amp. Connect one end of the 2 foot wire to +13.8VDC at the Phase controller to +13.8VDC terminal on the 75Ω Pre-amp, this supplies power. The ground connection is made through the RG6 coax shield. The OUTPUT from the Pre-amp PLUS is connected to the RG6 feed coax to the shack. On the shack end of the coax insert the 75/50Ω Transformer. The output of the Transformer requires a BNC male connector. This end will connect to your RX port / connector.



Long Delay Cable & Control View



Short Delay Cable and Power View

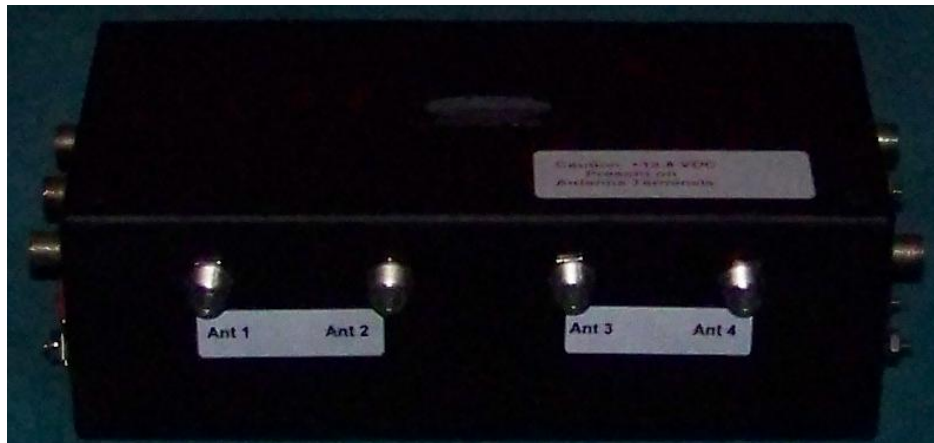

Antennas 1 - 4 View

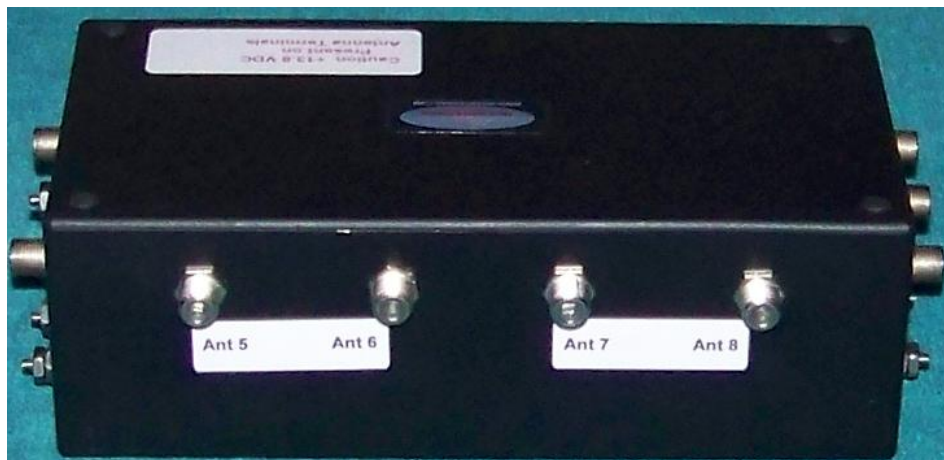

Antennas 5-8 View





Hi-Z 75Ω Pre-amp PLUS



Hi-Z 75Ω to 50Ω Transformer

The direction-switching table is as follows.

### DIRECTION

1=	Ground Ctrl 1	N
2=	Ground Ctrl 2	NE
3=	Ground Ctrl 3	E
4=	Ground Ctrl 4	SE
5=	Ground Ctrl 1 & Ctrl 5	S
6=	Ground Ctrl 2 & Ctrl 5	SW
7=	Ground Ctrl 3 & Ctrl 5	W
8=	Ground Ctrl 4 & Ctrl 5	NW

The output impedance of the array is 75 ohms. Although you could likely get away with just connecting it to you 50-ohm receiver under a lot of conditions, it is best if you use a matching 75 to 50 ohm transformer. This allows the included preamplifier to give maximum IMD performance.

**The Coax Power In terminal is provided to disconnect the +13.8VDC sent out to all the controller antenna inputs for powering the Hi-Z PLUS6 amps at the elements. Removing the factory jumper removes the voltage on the antenna inputs.**

Signal Sources (handy device for testing and troubleshooting) [http://www.hizantennas.com/signal\\_source.htm](http://www.hizantennas.com/signal_source.htm)

For BCI:

Hi-Z Band Pass Filter (BPF) [http://www.hizantennas.com/high\\_pass.htm](http://www.hizantennas.com/high_pass.htm)

Hi-Z High Pass Filter (HPF) [http://www.hizantennas.com/band\\_pass.htm](http://www.hizantennas.com/band_pass.htm)

### **Troubleshooting:**

Please look on our website at [http://www.hizantennas.com/hiz\\_faq.htm](http://www.hizantennas.com/hiz_faq.htm)

Technical Support: [contact@hizantennas.com](mailto:contact@hizantennas.com)

**Other Resources:** [http://www.hizantennas.com/application\\_notes.htm](http://www.hizantennas.com/application_notes.htm)

### **Quick Start Guide**

1. Lay out the 200-foot diameter (160 meters) or the 100 foot circle (80 meters) where nothing can come within about 5 to 10 feet of each element.
2. Install the 8 Hi-Z type elements in the spacing of your choice. Check each element to make sure they are insulated with very low leakage.
3. If the mounting post cannot be used as a ground rod then install a ground rod at each element. In really dry, or shallow earth, two or more short rods should be used.
4. Prepare the element interconnecting cables by using the spool technique suggested in the connecting cables paragraph. Install F connectors on each end of the cables.
5. Connect the Hi-Z amps PLUS6 to the elements making sure the antenna terminal connects to the element and the ground terminal goes to the ground rod.
6. Connect the interconnect cables to the F connector on each Hi-Z PLUS6 amp and arrange the free end of the cables toward the center of the array.
7. Connect the delay cables to the controller. The system is shipped with factory made LONG and SHORT delay cables and these are connected to their respective connectors on the phase controller.
8. Place the Hi-Z antennas 8 element controller in the center of the array. Connect the first left of North (element 1) element to antenna 1 input on the controller. Proceed clockwise around the array in a circle connecting the elements to input 2,3, and up to 8.
10. Connect a +13.8 VDC supply to the power terminals on the controller. It is also possible to use a 6-wire control cable from the shack to the controller. The Shield of the feed line from the shack can be used for the power ground connection and another conductor to supply the +13.8VDC. It is highly recommended that you use a separate ground wire for long runs to the shack. **It is imperative the supplied voltage at the controller terminal does not go below 12 VDC under load.**
11. Connect the Hi-Z 8 element controller shack switch box to the power supply at the shack and the control lines to the correct terminals on the controller at the array.
12. The array should be complete and ready to use when the feed line is connected to a receiver. Install the Hi-Z 75 to 50 ohm transformer to feed the normally 50-ohm input of the receiver. External receive antenna ports are best to use, as the array will not survive an accidental transmission of RF into the array output!

## 8 Circle Array Layout of Verticals

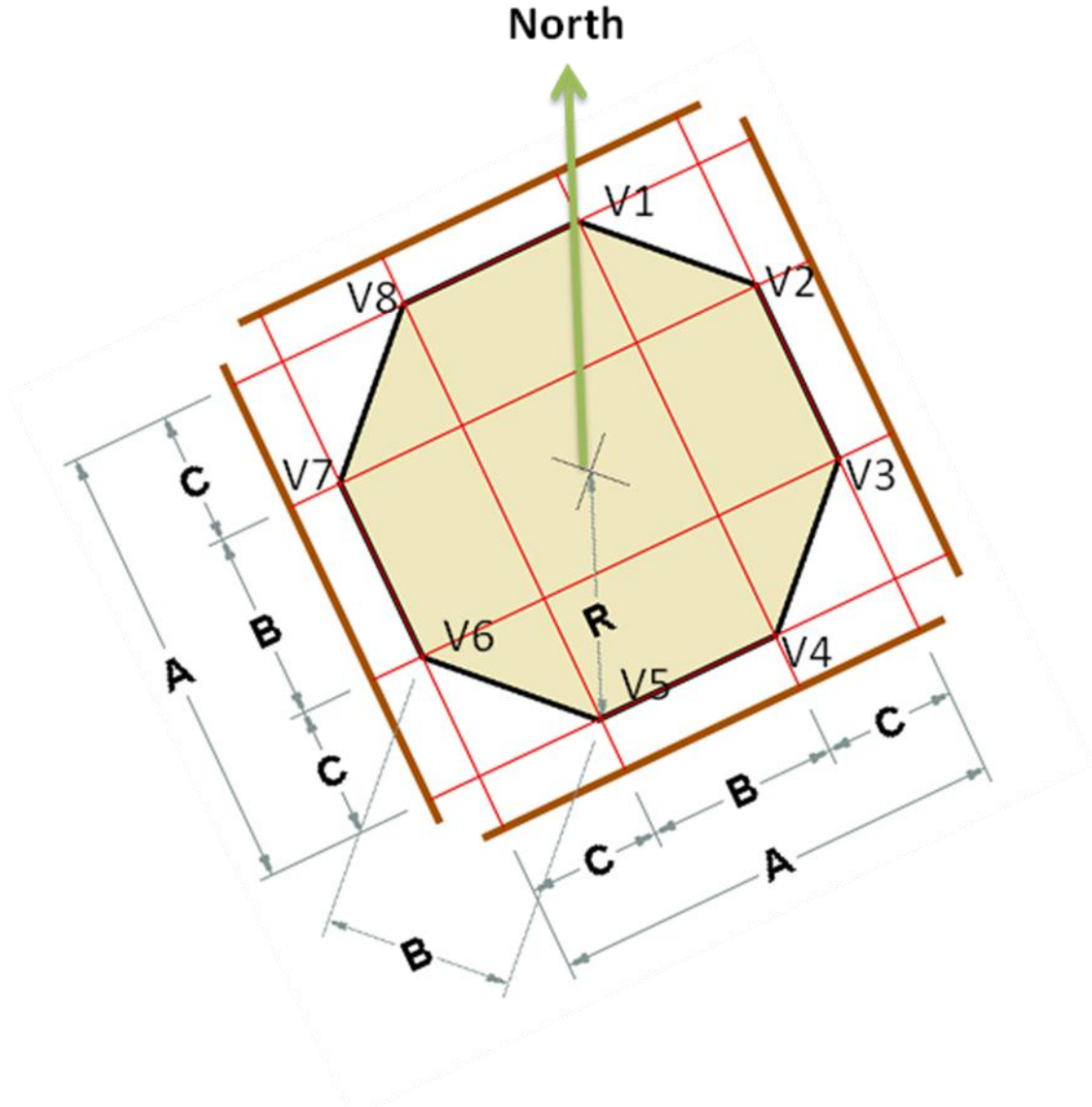

V1 – V8 = Verticals 1-8. Each vertical is 45 degrees spacing.

MODEL	Diameter	Radius	A	B	C
Hi-Z 8A – 160	200	100		76' 6 7/16"	54' 1 7/16"
Hi-Z 8A – 80	100	50	92' 4 5/8"	38' 3 1/4"	27' 11/16"

**NOTE: All measurements are rounded to the nearest 1/16".  
All coaxes from controller to the vertical are equal length (Radius + 4 feet).**



**HIGH PERFORMANCE**

**HF RECEIVING SYSTEMS & COMPONENTS**

## Hi-Z Antennas™ Hi-Z Amplifier PLUS6



Hi-Z Amp PLUS6

The Hi-Z Amplifier PLUS6 was designed to provide amplification and matching between the short verticals and the phase controller in the Hi-Z phased array control systems. This amplifier is used on ALL Hi-Z phased array products. The amp is located at the base of each short vertical. The connecting wires must be short, in the range or 8-10 inches long. When dressing or routing the wires between the vertical and ground rod to the Hi-Z PLUS6 Amps, maintain as much separation between the ground and antenna wires as possible. If these wires are too close it will degrade the system performance.

Please review our application and technical notes to gain ideas for mounting the Hi-Z PLUS6 amplifiers near the base of the verticals. See: [http://www.hizantennas.com/hiz\\_verticals.htm](http://www.hizantennas.com/hiz_verticals.htm)

### **Specifications:**

- Increased gain model – PLUS6 0dB (both models maintain 75 ohm output impedance)
- L=4.6 W=2.6 H=1.6 (not including the terminals or connectors)

### **Features & Benefits:**

- Rugged weatherized enclosure
- No need to cover the amp, simplified mounting
- Reduces cost (enclosures) and time to mount and connect the Amp to the vertical elements



Terminals to Ground and Vertical



Hi-Z PLUS6 Amp RG6 Output

**Mounting Detail:**

**Hi-Z Amp PLUS & PLUS6 Enclosure Layout**



Overall dimensions:  
4.5" long X 2 9/16" wide

Two mounting holes accessible  
By removing the top cover plate.  
Each hole is 3/16" diameter.

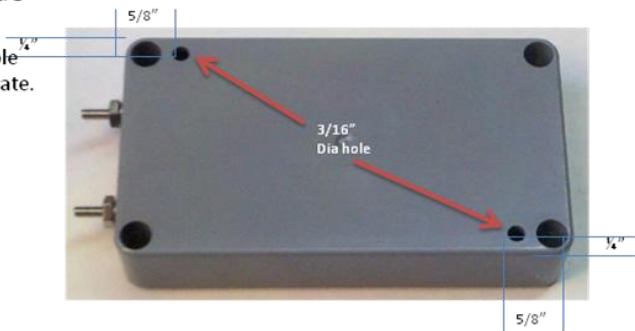

THANK YOU for selecting Hi-Z Antennas™.

Hi-Z Antennas™  
8125 SW Larch Drive  
Culver, OR 97734  
USA

\*\* The Hi-Z 4, Hi-Z 8N, and the Hi-Z 8W products are being sold as permitted under the terms of a certain License Agreement among PDS Electronics, Inc. dba DX Engineering, as the Licensor, and Hi-Z Antennas and Lee Strahan, as the Licensees.