

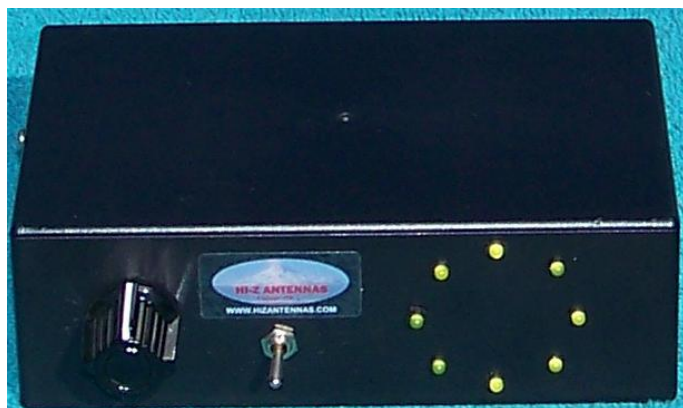

HIGH PERFORMANCE HF RECEIVING SYSTEMS & COMPONENTS

Hi-Z Antennas™ 4-8 PRO UP Level2 8 Element Circle Array Manual

Converts the Hi-Z 4 to the Hi-Z 4-8PRO



Hi-Z 4-8PRO Shack Switch

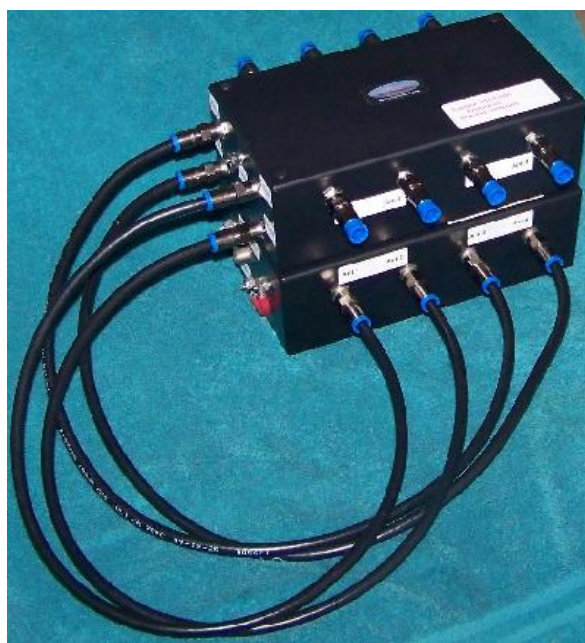

Hi-Z 4-8PRO PnP Interface Top/ 4 El. Controller Bottom

Congratulations and Thank You for the purchase of our system. *We recommend that you read this manual and fully understand the requirements for the proper installation of your system.*

Specifications

- Maximum RDF 12.1db
- 8 Directions
- Power Requirements 13.8 VDC @ 350ma

Features:

- 8 Directions, every 45 degrees
- Hi-Z 4-8PRO as a new install
- Field upgrade of existing Hi-Z 4 systems to Hi-Z 4-8PRO UP
- Pushing the envelope of best performance in the smallest possible footprint (113 foot diameter)

Benefits:

- Substantially reduced signal attenuation at direction overlap points
- 160, 80, 40 meters coverage
- Hi-Z PLUS6 Amp design, no need for radials (we do not use passive elements)
- Uses the same area of the Hi-Z 4 (80ft. sq.) footprint, just add 4 more elements

At the end of the manual there is a vertical payout diagram with dimensions.

Component List for the Hi-Z 4-8PRO System

- 1 – Hi-Z 4-8PRO PnP Controller
- 1 – Hi-Z 8 direction shack switch
- 4 – Hi-Z PLUS6 Amps
- 4 – 2 foot long RG6 cables
- 2 – 2 foot long wire with terminals (power to PnP controller)

Background Information & Design Philosophy

Trying to use a 4 element system for 8 directions creates too many compromises and limited performance typically in the 4 directions at 45 degrees to the diagonals. This was not an option. The standard 4 element RX array system has an inherent weakness at the 4 overlap points. For example, when clicking between NE and SE directions, trying to listen to a signal from the East, this signal would typically be down by >4db as it is in the overlap region. The goal was to have the directional RDF of the standard Hi-Z 4 (12.2RDF) in 8 directions with minimal attenuation at the overlap. Another design goal was to make it upgradeable with existing Hi-Z 4 installs as simple as possible. Since the Hi-Z 4 is typically installed in an 80 foot square pattern, this is a 113 foot diameter circle, was to add the 4 additional elements in-between the existing 4 elements. Thusly, maintaining the same radius for all elements.

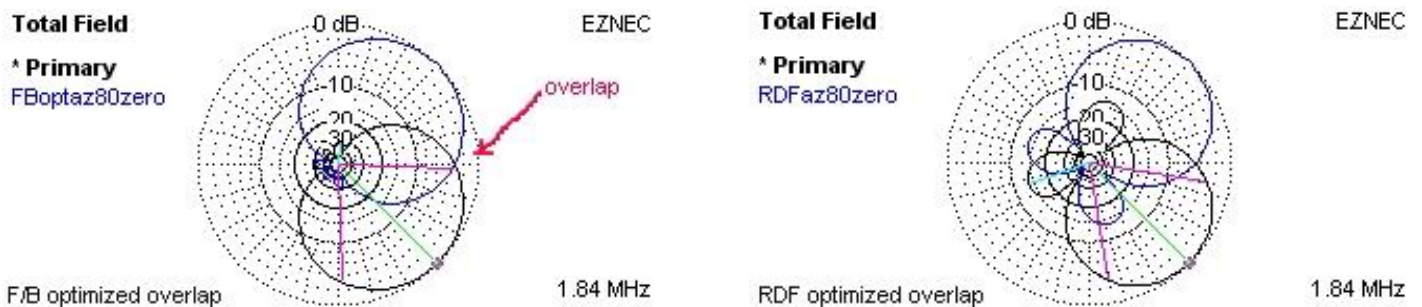

Note: overlap point down by >4db

The directional lobe of the Hi-Z 4-8PRO is the same as the Hi-Z 4.

^ Total Field

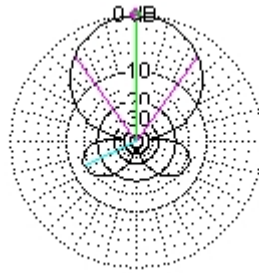

EZNEC

4-8North

1.85 MHz

Hi-Z 4-8PRO Plot

Next are the North and Northeast patterns of the Hi-Z 4-8 overlapped.

Total Field

^ Primary

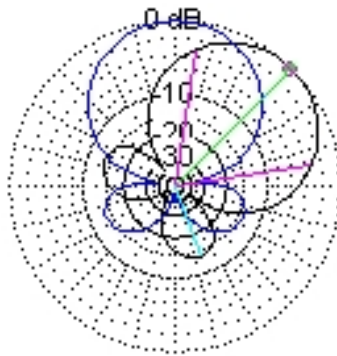

EZNEC

1.85 MHz

Next is the plot three directions of the Hi-Z 4-8PRO overlapped (N, NE & E).

Total Field

^ Primary

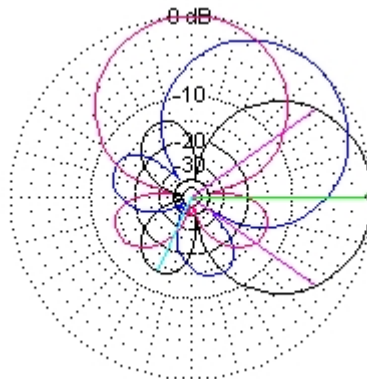

EZNEC

1.85 MHz

Compare the attenuation at the overlap of the 4 element to 8 element design. At the 8 overlap points the attenuation is ~1db. Therefore, gaining >3db at the overlap points, not to mention the 8 direction control.

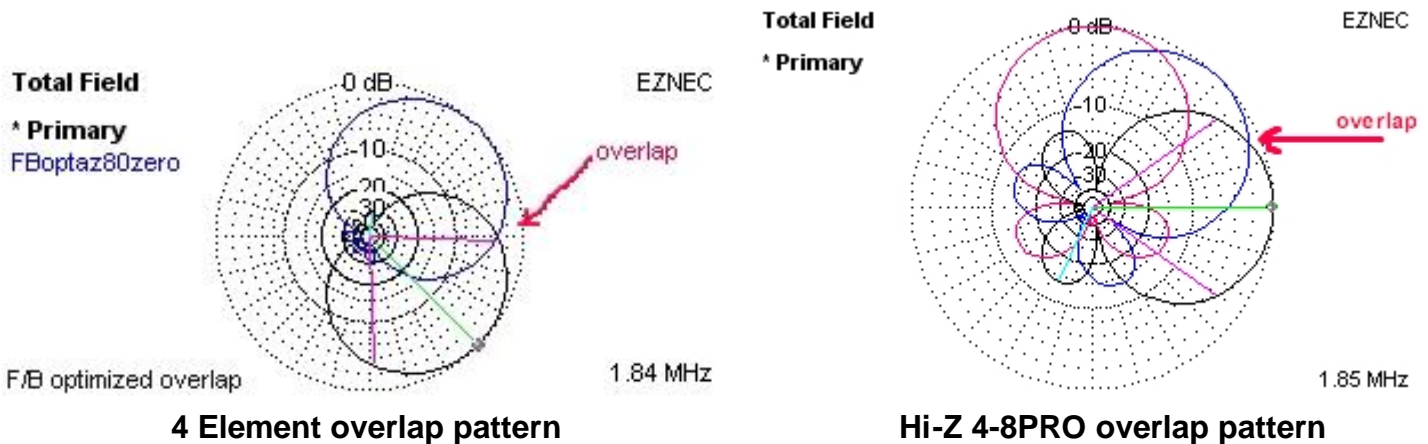

Material That the Customer Supplies -

1. Additional control wire for CTRL3 connection (if using a 4 conductor cable, the GND connection can be used going through the RG6 feed coax shield, freeing up one control wire for CTRL3 connection).
2. 4 more verticals exactly like (same height as) or use our verticals, look at http://www.hizantennas.com/hiz_verticals.htm
3. 4 more short ground rods. Depending on soil type, in the range of 2 –3 feet long.
4. RG6 coax and connectors (connecting the 4 extra verticals to the phase controller and these for new runs MUST be the same length as the currently installed runs).
5. Make 8 more 9-10" long wires. Wire size can be made from 18 – 20 gauge wire. Terminate each end with #6 ring terminals. Recommend that after the terminals are crimped, that these terminals are soldered for reliability. For Hi-Z Amp terminations. These are to connect the 4 new Hi-Z PLUS6 Amps to the new verticals.
6. **Weatherproofing the electronics.** You will need an adequate cover or enclosure that will keep rain and snow off the phase controller, in-line pre-amp and filters if installed, and the Hi-Z PLUS6 Amps at the base of each vertical. Water getting inside of these enclosures WILL cause DAMAGE.

OPTIONS

Filters for site specific issues, for example local and or high power AM broadcast stations. Hi-Z Antennas™ makes a BPF look at http://www.hizantennas.com/band_pass.htm and a HPF look at http://www.hizantennas.com/high_pass.htm

SITE PREPARATION

Place the verticals as far away from metallic structures or other towers and antennas as possible, especially resonant antennas. The farther the better. Keep away from field fencing at least 10 feet. Keep the verticals more than 5 feet from trees and heavy vegetation.

Control Cable and Coax Considerations

1. Recommended RG6 F connector tightening process. See appendix A.
2. Conductor wire gauge selection is a function of the length of the control cable. 18 gauge wires are adequate out to 500 feet. Any longer will need to increase wire gauge size to accommodate the voltage drop over the run of cable length. An inexpensive source of cable is from Lowes, Home Depot, etc in their electrical department. They have 5, 7, 9 conductor, 18 gauge direct burial sprinkler control cable. Usually they will have it on large spools and can be cut to the length you require. Always get extra.

3. Make sure that the RG6 connectors are tight and of good quality.
4. If you crimp on terminals on the control cable, go the extra step and solder each terminal for reliability.

Vertical Placement and Installation of the Hi-Z PLUS6 Amplifiers

1. Determine where the array (verticals) will be mounted.
2. The verticals need to be as far away as possible from other antennas, tower and other metallic structures. Especially if the other antennas are resonant, this will lower performance.
3. Locate the ground rods close to the base of each vertical.
4. Determine the direction orientation. You have 8 directions. So orientation of the verticals is critical to achieving the directional performance you require and can be different in locations around the world. In the case of the Hi-Z 8PRO the new verticals will go in-between the existing verticals. Now there will be one vertical every 45 degrees. Typically Vertical 1 is oriented to North, Vertical 2 to NE through Vertical 8 at NW and so on in a CW fashion.
5. See the diagram on the last page. This will assist you in laying out the accurate placement of your four added verticals.
6. Add the extra control line for CTRL3 (or use the RG6 shield in the feed coax) long enough to get from the shack switch to the phase controller.
7. You will need a length of RG6 coax about the same length to connect the output of the in-line pre-amp (at the phase controller) to your receiver port through the Hi-Z 75 to 50Ω transformer.
8. Typically the Hi-Z 4-8 phase controller and Hi-Z 4-8PRO PnP controller are located in the center of the array. That is not necessary. However, where these two controllers are located the 8 RG6 coaxes from the Hi-Z 4-8PRO PnP controller to the base of each vertical MUST be cut and terminated to the same length.
9. Mount the additional 4 verticals (either homebrew or Hi-Z verticals).
10. Mount the Hi-Z PLUS6 Amplifiers at the base of each vertical. Connect one wire from the Antenna terminal to the base of the vertical. Connect another wire from the Ground terminal to the ground rod. See Hi-Z Amplifier.
11. Connect each RG6 coax from output of Hi-Z amp to the correct Ant 1, 2, 3, 4, 5, 6, 7 and 8 at the PnP controller.
12. Weatherproofing the Hi-Z Amp. Place a cover over (or other such enclosure) the Hi-Z Amp to insure that rain or snow does not fall on or get trapped with the enclosure. See our website under vertical for ideas on weatherproofing - http://www.hizantennas.com/hiz_verticals.htm



Hi-Z PLUS6 Amplifier

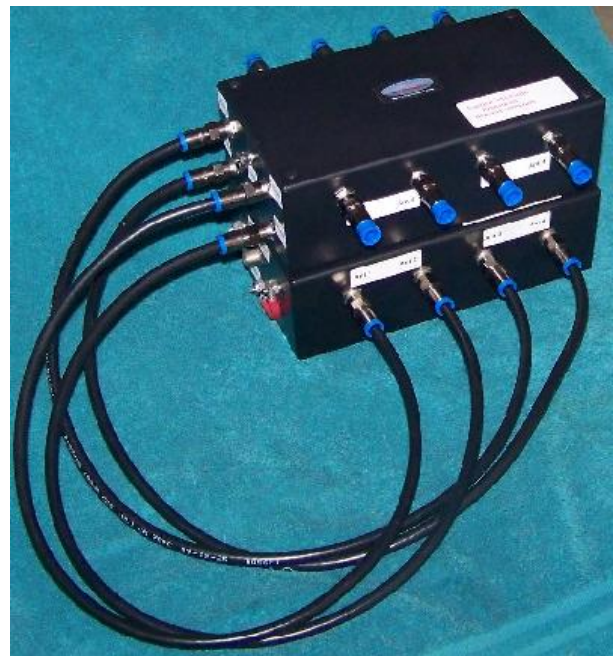

Hi-Z 4-8PRO PnP Interface Top/ 4 El. Controller Bottom

The following Block Diagram is a visual aid for the wiring and cabling required to install the Hi-Z 4-8PRO System.

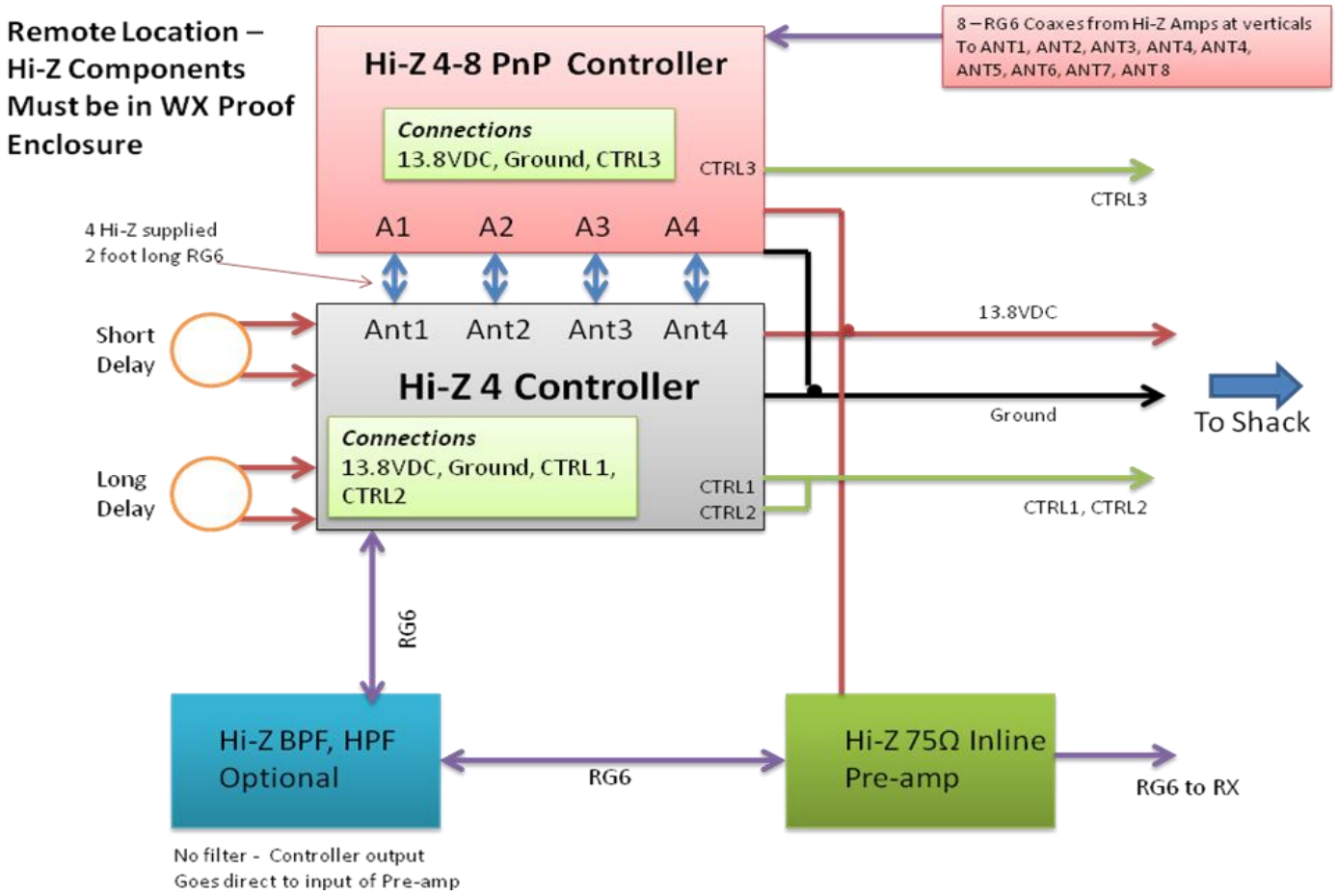

Connecting the Hi-Z 4-8PRO controller to the Hi-Z 4-8PRO PnP Controller

1. Connect the four factory supplied 2 foot long RG6 cables as follows

Hi-Z 4-8PRO phase controller connect TO	Hi-Z 4-8PRO PnP controller
Ant1	A1 out
Ant2	A2 out
Ant3	A3 out
Ant4	A4 out
See Fig. 2 below	See Fig. 1 below



Fig.1



Fig.2

Connect the Control Cable – Ctrl 3 as shown in Fig.1.

Connect one of each 2 foot jumper wires with terminals to the Ground and 13.8VDC terminals, see Fig. 3. The other end on these wires will terminate to the same labeled terminals on the Hi-Z 4-8PRO phase controller, see Fig.4.



Fig. 3



Fig. 4

Both controllers will be supplied with a RED jumper connected between the 13.8 VDC and Coax Power In terminals. This supplies the voltage to the Hi-Z PLUS6 amps over the coax. Do not remove this jumper.

Connecting the Verticals and Delay Cable to the Phase Controller

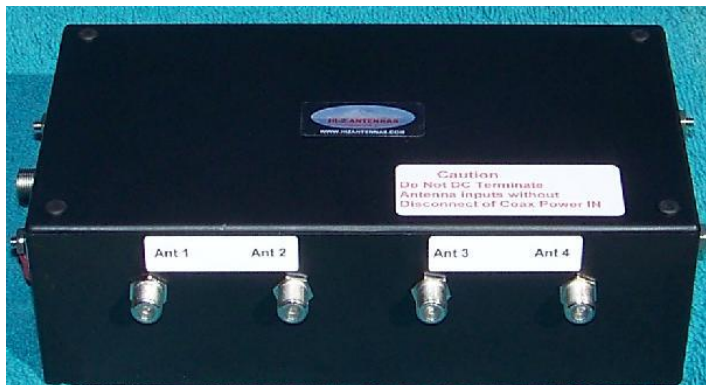

Fig. 5



Fig.6

1. Run equal lengths of RG6 from the Hi-Z 4-8PRO PnP controller to each vertical. This connects to the Hi-Z 4-8PRO PnP controller Ant 1-8 to verticals 1-8. Be certain to observe these connections based on the orientation or placement of verticals for correct aiming. Fig. 5 & Fig.6 These cables MUST be the same length as currently installed with the Hi-Z 4.
2. Connect the Hi-Z supplied short and long Delay cables at Short Delay and Long Delay connectors on the Hi-Z 4-8PRO phase controller. Fig.7



Fig. 7

Connect the factory supplied 2 foot wire jumper with fork terminals from either of the 13.8VDC terminals on the controllers and connect the other end to the 13.8VDC terminal on the 75Ω In-line pre-amp.
 Connect the factory supplied 2 foot RG6 cable from the OUTPUT of the Hi-Z 4-8 phase controller (Fig.4) to the input connector on the in-line pre-amp. See Fig. 8
 Connect the 13.8VDC and GND from the phase controller to the PnP controller (2ft long wires, supplied with system).



Fig. 8

Connecting the Phase Controller to the Shack Switch and Receiver Fig. 3, 4 & 5

1. Connect CNTL3 (these are located on the Hi-Z PnP controller) to shack CTRL3 on the switch.
2. Wire the power 13.8 VDC and Ground from shack switch to either of the controllers. Fig. 9
3. OPTIONS. If a HPF or BPF filter was purchased or customer supplied, the filter MUST be inserted between the controller output and before the inline preamp (best IMD).
4. Connect feed RG6 to the output of the in-line pre-amp to the Hi-Z 75 to 50Ω transformer in the shack and the other end of the transformer connects to the RX input.
5. Use your existing power cable at the existing Hi-Z 4 shack switch for your new 8 direction shack switch.



Fig. 9

Shack Preparation and Basic Operation

1. Locate the placement of the shack switch.
2. Verify the voltage level is in the 13.8 VDC area. Depending on the length of the control cable this voltage may need to be adjusted upwards to compensate for any voltage drop.
3. Direction control. Typically; Position 1 = N, 2= NE, 3 = E, 4 = SE, 5 = S, 6 = SW, 7 = W and 8 = NW.

Power Up and System Checks

1. Turn power on at the shack switch. One yellow direction LED should be ON. Rotate the direction rotary switch and verify that all 8 LEDs sequence correctly.
2. Measure the voltage at the phase controller. 13.8VDC is ideal. Voltage must be ≥ 12.0 VDC.
3. Check the RED LEDs at the Hi-Z PLUS6 Amps at the base of each vertical, they should ALL be ON.
4. Tune to 160 or 80 meters. Switch On and Off the power at the Hi-Z shack switch and you should hear the noise floor increase when switched ON. If able, compare to existing antennas, the noise floor on the Hi-Z system will likely be much lower.
5. Test the directivity by tuning the AM broadcast band above 1 MHz (with no HPF or BPF filter installed). When pointed at a station and the signal is peaked, turn the control to other directions and observe the F/B and F/S.
6. On the air, especially low angle DX, you will observe best performance in terms of pattern. When a signal is peaked in one direction, try switching in the direction either side you will see the signal decrease considerably. As you continue to turn the direction control and observing the signal level, the F/S and F/B performance will become apparent.
7. The advantage is the S/N that our system produces. Good DX'ing.

TROUBESHOOTING also see http://www.hizantennas.com/hiz_faq.htm

Symptom:

Spurs every 10 KHz across 160 meters. Check the Hi-Z PLUS6 Amp connections one of the Hi-Z PLUS6 Amp has the two wires (Antenna, Ground) reversed, verify these connections are wired correctly.

Some switching power supplies can cause this symptom.

Measure the DC voltage on the vertical. From ground to the vertical with a DVM you should measure ~ 4 volts VDC. Improper voltage readings indicate wiring problem.

Low IMD. Verify that the voltage at the +13.8VDC and Ground terminals at the phase controller measures ≥ 12.0 VDC. Sometimes due to control cable lengths one may need to consider a separate adjustable voltage power supply to insure correct operation voltage for the Hi-Z system.

Hi-Z PLUS6 Amps – No RED LED ON

Verify that there is a jumper on the phase controller between the 13.8 VDC and Coax Power In terminals.

Birdies, Heterodyning

Causes include close proximity to broadcast stations.

Solutions: One the source of this problem is located, the insertion of either a Hi-Z BPF or Hi-Z HPF, depending on the source of interference, should be inserted between the output of the phase controller and the input to the 75 Ω in-line pre-amp.

Directions Seem Wrong

Verify that you connected vertical 1 to controller Ant1, vertical 2 to controller Ant 2 and so on.

For other topics see technical & application notes at http://www.hizantennas.com/application_notes.htm



HIGH PERFORMANCE

HF RECEIVING SYSTEMS & COMPONENTS

Hi-Z Antennas™ *Hi-Z PLUS6 Amplifier*



Hi-Z PLUS6 Amplifier

The Hi-Z PLUS6 Amplifier was designed to provide amplification and matching between the short verticals and the phase controller in the Hi-Z phased array control systems. This amplifier is used on ALL Hi-Z phased array products. The amp is located at the base of each short vertical. The connecting wires must be short, in the range or 8-10 inches long. When dressing or routing the wires between the vertical and ground rod to the Hi-Z PLUS6 Amps, maintain as much separation between the ground and antenna wires as possible. If these wires are to close it will degrade the system performance. *The Hi-Z PLUS6 Amp MUST be Weatherproofed!!*

Please review our application and technical notes to gain ideas for mounting the Hi-Z PLUS6 amplifiers near the base of the verticals. See: http://www.hizantennas.com/hiz_verticals.htm

Features:

- Relay input (lightning and static protection, when power is off)

- Easy connections to the base of the vertical and ground



Terminals to Ground and Vertical



Hi-Z PLUS6 Amp RG6 Output

THANK YOU for selecting Hi-Z Antennas™.



Hi-Z Antennas™
8125 SW Larch Drive
Culver, OR 97734
USA

Vertical Orientation

Hi-Z 4-8PRO & 4-8PRO UP - Reference

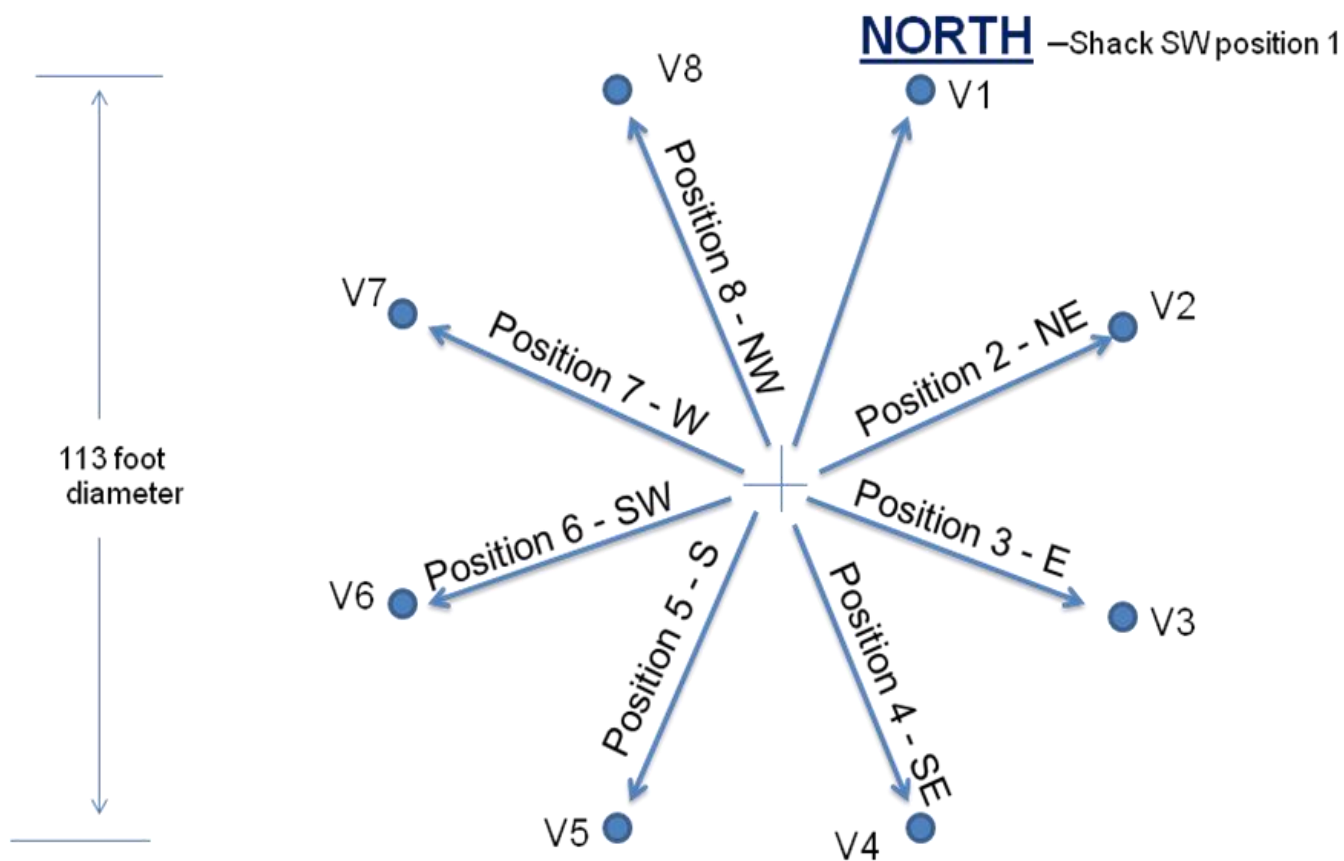



8 Circle Array Layout of Verticals

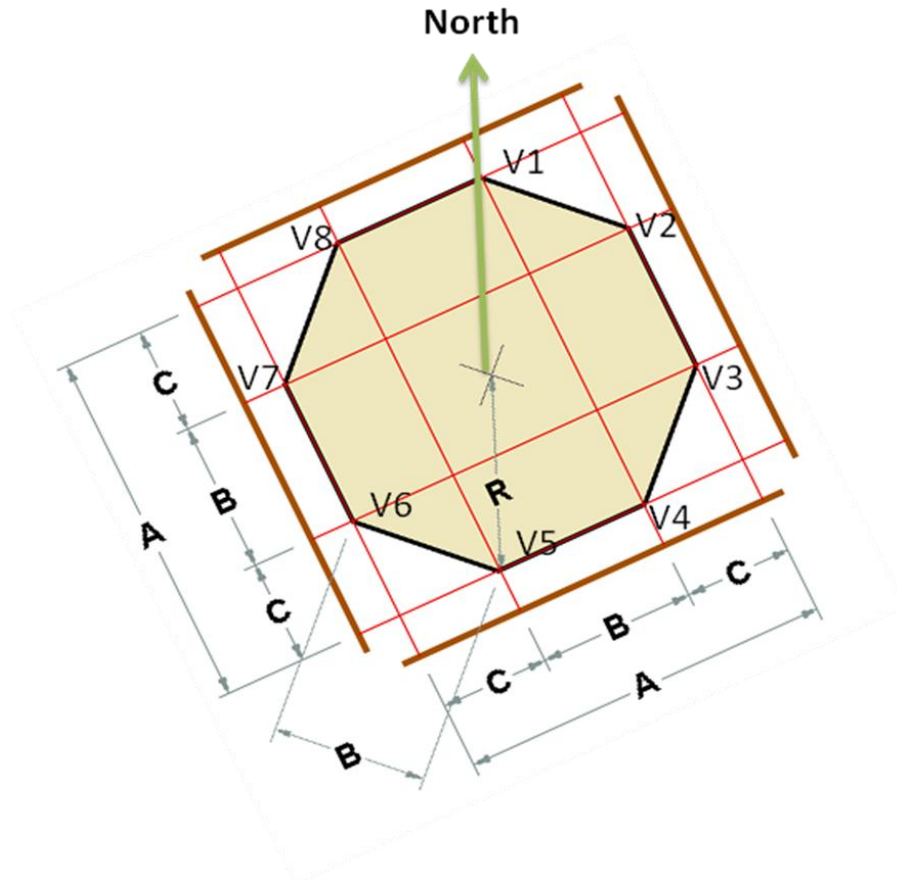

V1 – V8 = Verticals 1-8. Each vertical is 45 degrees spacing.

MODEL	Diameter	Radius	A	B	C
Hi-Z 4-8PRO	113 *	56.5	104' 4 3/4"	43' 2 15/16"	30' 6 15/16"
Hi-Z 4-8PRO	84.5 **	42.25	78' 13/16"	32' 4 1/16"	22' 10 3/8"

NOTE: All measurements are rounded to the nearest 1/16".

* Based on Hi-Z 4 80 foot square footprint.

** Based on Hi-Z 4 60 foot square footprint.

All coaxes from controller to the vertical are equal length (Radius + 4 feet).

APPENDIX A

F connector tightening procedure. Placing a 7/16" wrench on the chassis connector while holding it tight, place another 7/16" wrench over the Male connector housing and tighten until snug. Do not over tighten this F connector. View pictures below.

